





Screened Porch

Using

29" Tall PVC Panel

with PT Cap

	Wood		5/4 edge board
	PT Laminated Post		Stop
	PVC		

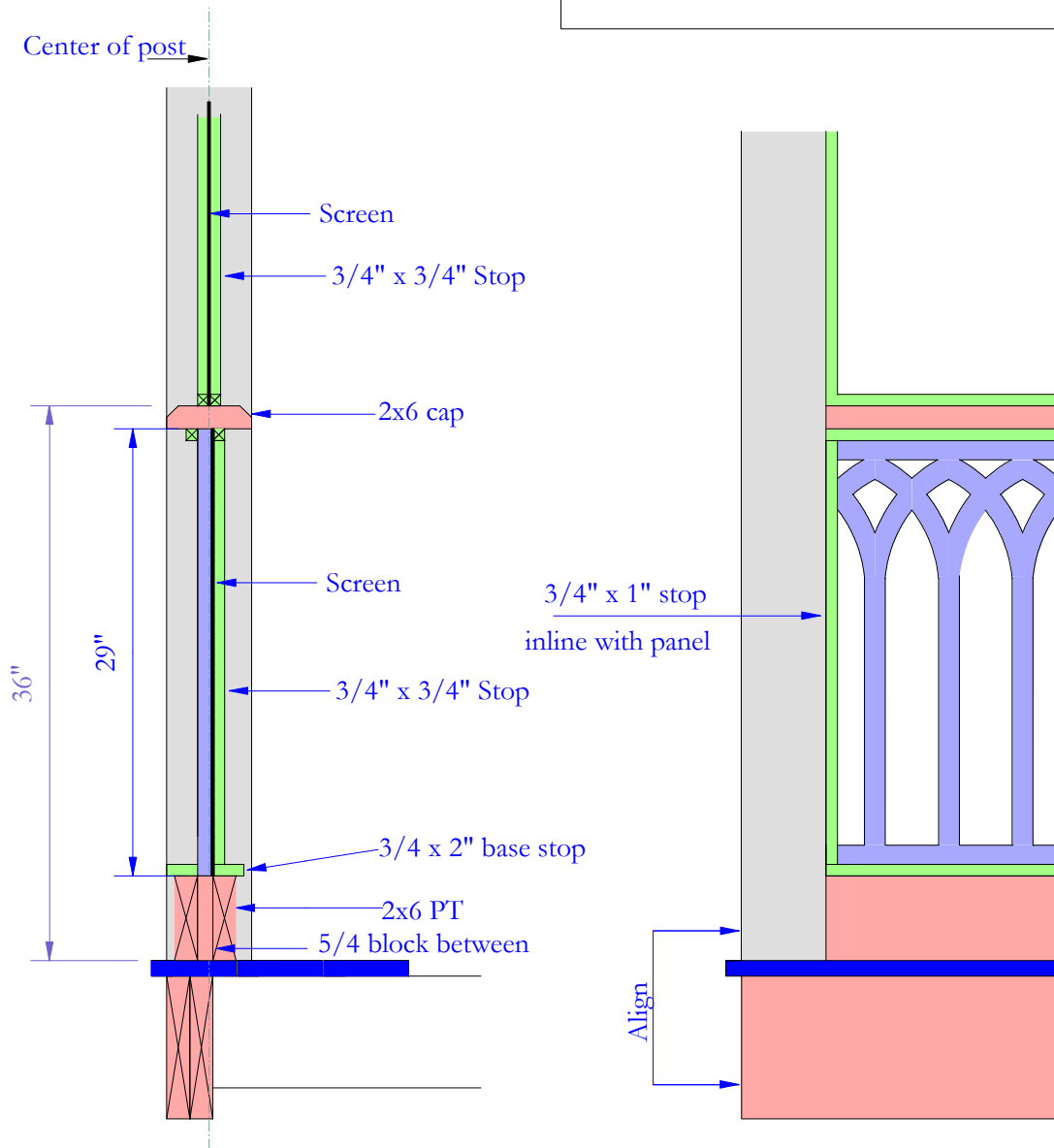





Wall Section

Exterior View

Screened Porch





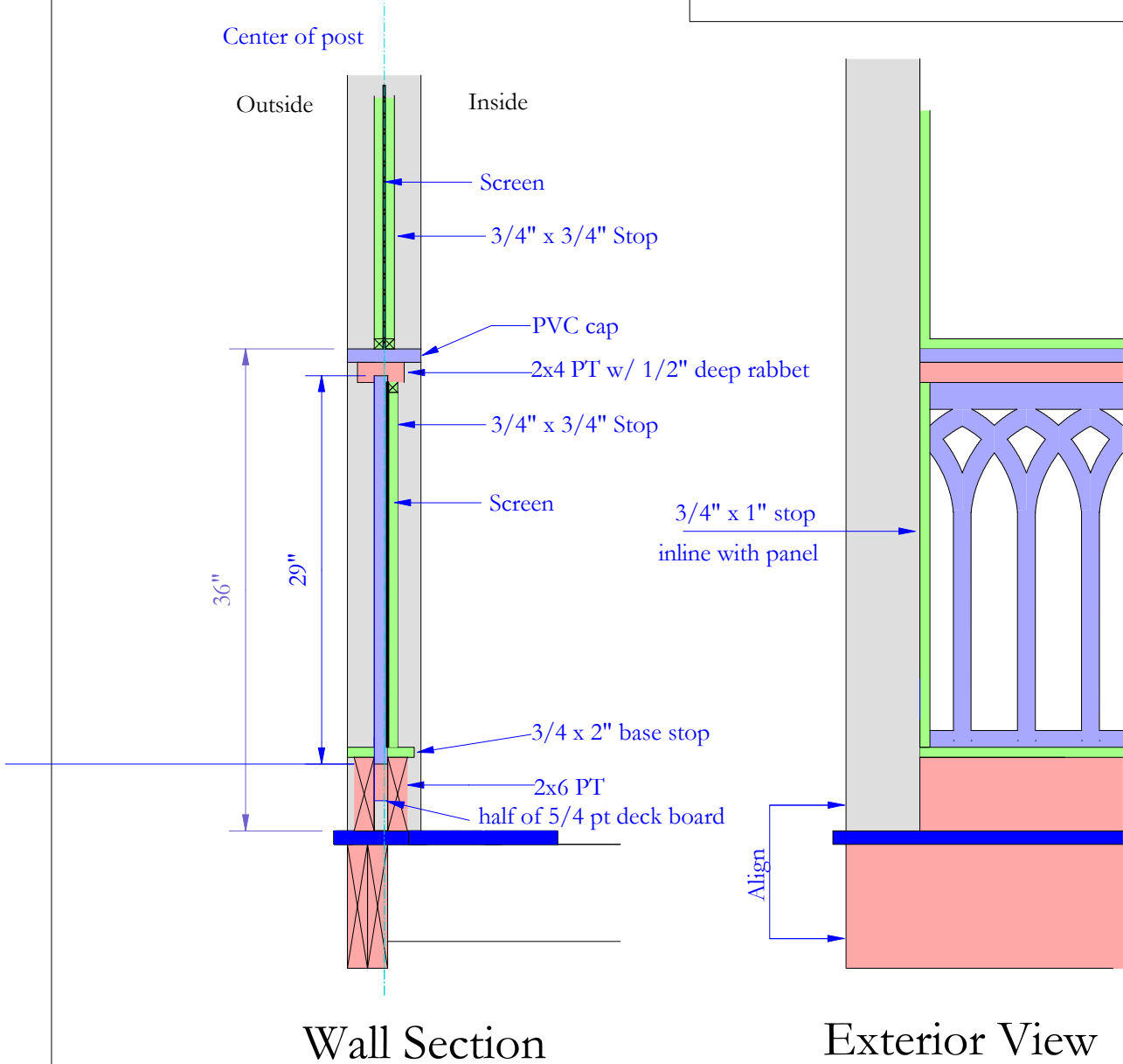



Using
29" Tall PVC Panel
with PVC Decking for Cap

 Wood	 5/4 edge board
 PT Laminated Post	 Stop
 PVC	



1" PVC Rails 31" Tall

6x6 posts
with PT Cap

	Wood		5/4 edge board
	PT Laminated Post		Stop
	Aluminum Spindle		Holy Board
	Paulownia		PVC

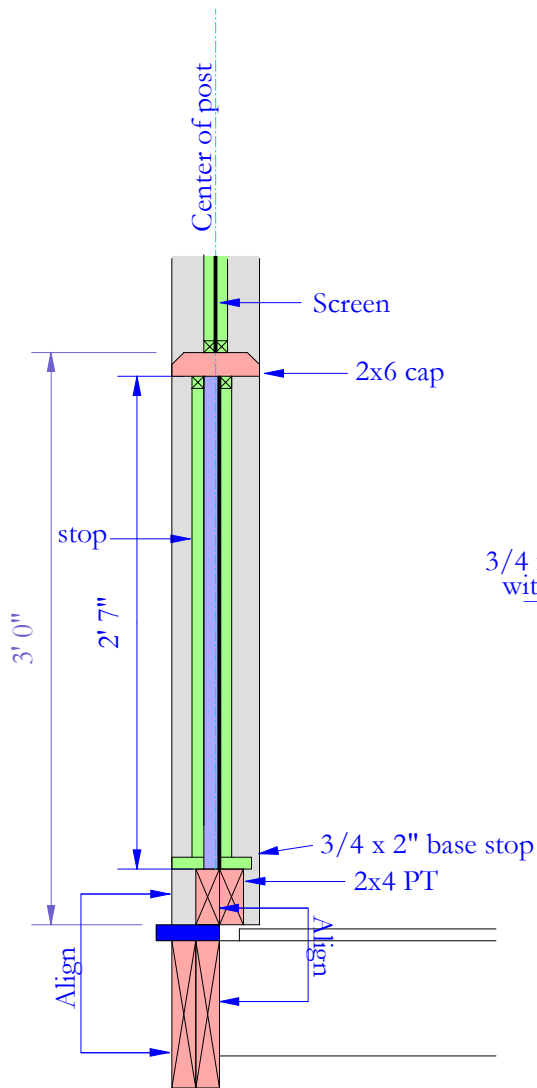

Wall Section

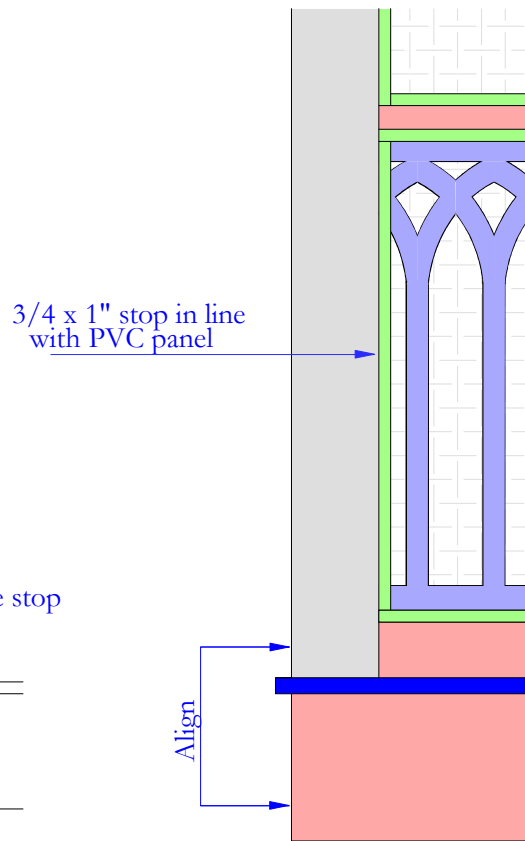





Exterior View

Screened Porch

Using

31" Tall PVC Panel with PVC Decking for Cap

 Wood	 5/4 edge board
 PT Laminated Post	 Stop
 PVC	

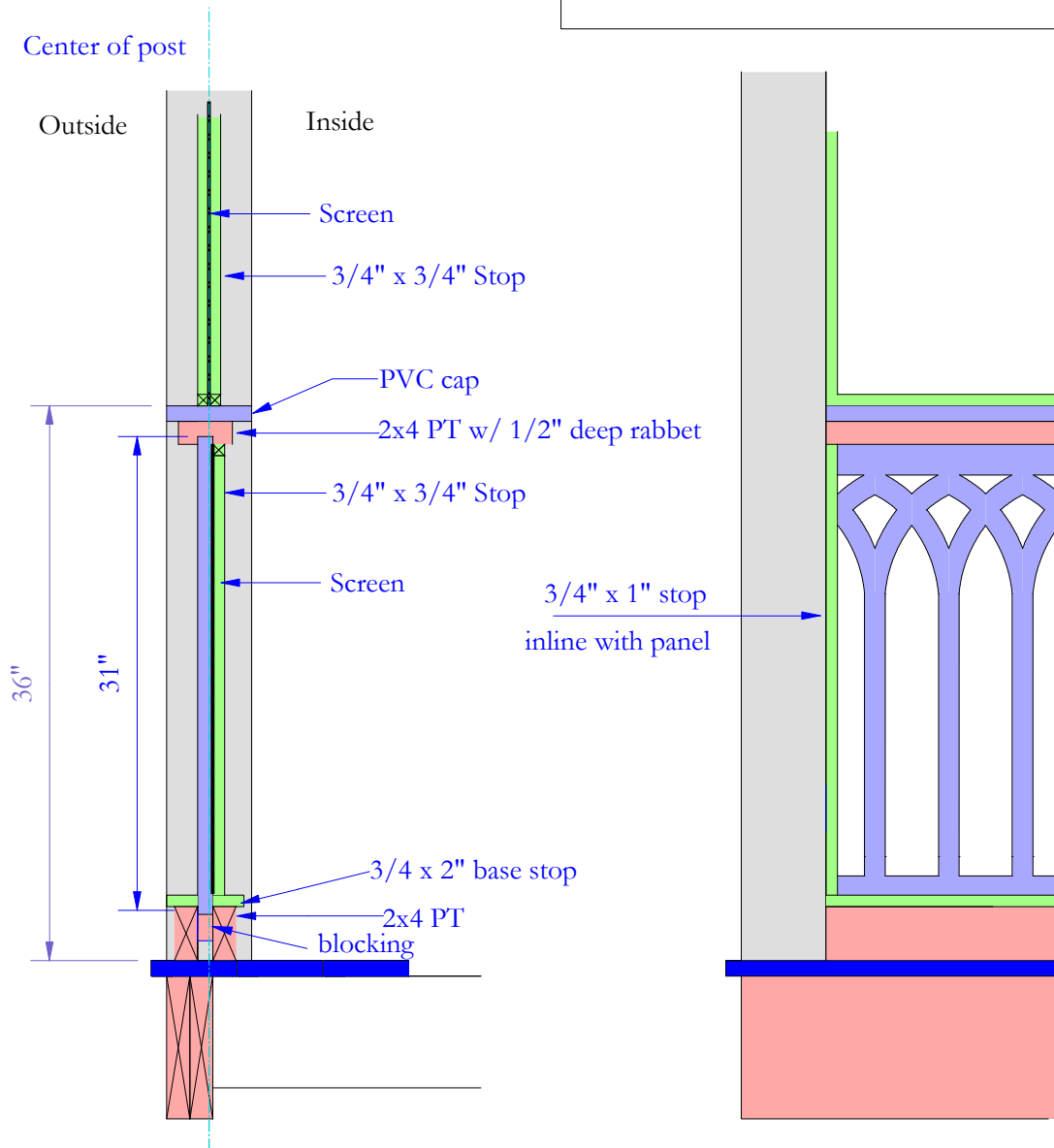

Wall Section

Exterior View